

# Design of Microwave Filters Topologies using a Hybrid Evolutionary Algorithm

Maria J. P. Dantas<sup>1</sup>, Leonardo da C. Brito<sup>2</sup>,

<sup>1</sup>Catholic University of Goiás (mjpd@cultura.com.br), <sup>2</sup>Federal University of Goiás (brito@eee.ufg.br),

Paulo H. P. de Carvalho<sup>3</sup>, Humberto Abdalla Júnior<sup>3</sup>

<sup>3</sup>University of Brasília (paulo, abdalla}@ene.unb.br

**Abstract**— This paper presents a Hybrid Evolutionary Algorithm applied to design of microwave filters topologies. In this approach the structure space is explored concerning predefined small building-blocks and topology-constraints rules. The method uses 2D representation, new strong genetic operators, combining a biobjective evolutionary algorithm to evolve topologies and local search to improve the circuit parameters. The optimization of circuit topologies and their parameters are simultaneously carried out. The results showed that the lumped-elements filters synthesized, are generated with small populations and few generations, producing small well-structured circuits, which accomplish the specifications. The results obtained are compared with those obtained by the conventional and/or evolutionary approaches. The performance measurement of method is given in circuit evaluations number to obtain a solution.

**Index Terms**— building-blocks, topology-constraints rules, 2D representation, hybrid evolutionary algorithm, microwave filter synthesis.

## I. INTRODUCTION

Analog design has not been automated to a great extent so far, mostly because of its overwhelming complexity. On the other hand, with analog designs becoming increasingly complex each day, there is a pressing need for analog circuit design automation. Besides that, recent works [1]-[7] show a renewed interest in filters. Many traditional techniques for direct synthesis are available in the literature [7]. However, in modern applications — wireless communication systems, for example - the rigorous specifications of filters demands by new methodologies that will be effective to aid the human designers to find structures of filter circuits capable of providing high frequency selectivity, and group delay equalization in order to meet efficient spectrum utilization and to reduce the distortion in a digital data transmission [1].

In the recent years evolutionary algorithms have increased success in producing results that are competitive with traditional human design. Genetic Algorithms (GAs), first introduced by Holland in 1975, have been widely used in engineering problems. Particularly, in Filter Design problem, using evolution-based paradigms (Genetic Algorithms and Genetic Programming), researchers (see [8]-[11], for example) have been able to evolve both circuit topologies and components values, without providing any prior specific design input to the algorithm. That is, they do not require expert

knowledge about the circuit topology. However, these methodologies have some basic drawbacks. A huge amount of completely invalid (anomalous) circuits are generated along the evolution process, thus increasing the time required for achieving good solutions. Besides that, they commonly generate extremely unconventional and unstructured circuit topologies, which can be physically unpractical. On the other hand, comparing these general-topology evolutionary methods and the most recent topology-restricted evolutionary approaches, the second are more efficient and desirable in some design cases, reducing the circuit complexity [12][13].

In this paper, we present a Hybrid Evolutionary Algorithm applied to design of microwave filter topologies. The proposed algorithm is based in expert knowledge obtained in the survey on the subject of the conventional design procedure (for example, [1]-[7],[14]-[16]). The topology-restricted approach was employed to place a set of moderate constraints on the structure of the candidate solutions, in order to reduce the search space and to avoid anomalous circuits, but with enough flexibility to allow the generation of novel topologies. The hybrid algorithm works with suitable representation and genetic operators that are specific to 2D encoding, and are capable of fomenting a balance between diversity and convergence. These elements were used to accelerate the convergence and help us producing regular topologies.

This paper is divided into four sections. In section II, the algorithm used is described. In section III, we present a synthesis experiments and discuss the results. Section IV offers concluding remarks and presents the perspectives for future works.

## II. PROPOSED METHOD

In this paper we consider the filter design problem as a multiobjective optimization problem, formulated as in [12]

$$g^* = \arg(\min_g U(S(g))) \quad (1)$$

where  $g$  denotes a chromosome and  $S(g)$  is the scattering matrix obtained by frequency simulator,  $U$  is the objective-functions set to be minimized and  $g^*$  is the appropriate chromosome (a circuit that complied with specifications).

The flowchart of the proposed Hybrid Evolutionary Algorithm to solve this problem is shown in Fig. 1. We can notice that the optimization of circuit topologies and their parameters are simultaneously carried out. An explicit search control for structures and parameters is required, balancing the exploration/exploitation on the topology and parameters space. The evolution strategies are used to avoid promising structures from being discarded because their parameters are not tuned well enough to show their potential. On the other hand, we also have that avoid that weak structures with better parameters proliferate and dominate the entire population, thus leading to premature convergence. The details about the main elements are given as following.

### A. Variable-size 2D Circuit Representation

The synthesis presented here uses the template circuit shown in Fig. 2. The building-blocks used to form the complete circuit (evolved circuit) are small lumped-elements circuits. They are available in a database and treated as black-boxes by the algorithm. The internal topology of a building-block cannot be changed. The rules for structural constraints allow us to connect well-known building-blocks while keeping the circuit structured and then avoiding the occurrence of anomalous topologies.

The circuit representation corresponds to an  $n$ -node undirected graph. So, it is enough an upper triangular matrix (hereinafter referred to as reduced matrix) for representation. The reduced matrix is directly handled by the algorithm without being necessary an equivalent linear encoding scheme (1D). In [17], a 2D matrix representation for circuit synthesis was proposed. The authors also proposed a 2D-to-1D transformation applied before the crossover process. However, as evidenced in [18], 2D-to-1D mapping results in loss of neighboring information between elements of the structure (a circuit, in this case) which can be harmful for the evolution process. The reduced matrix has the same size as the number of circuit nodes. Each entry  $(i, j)$  of the matrix represents a pair of external nodes which connect the two terminals of a building-block. Notice that  $i = j$  means that one terminal of the building-block is connected to the node  $i$ , and the other terminal is connected to the reference ground (node 0).

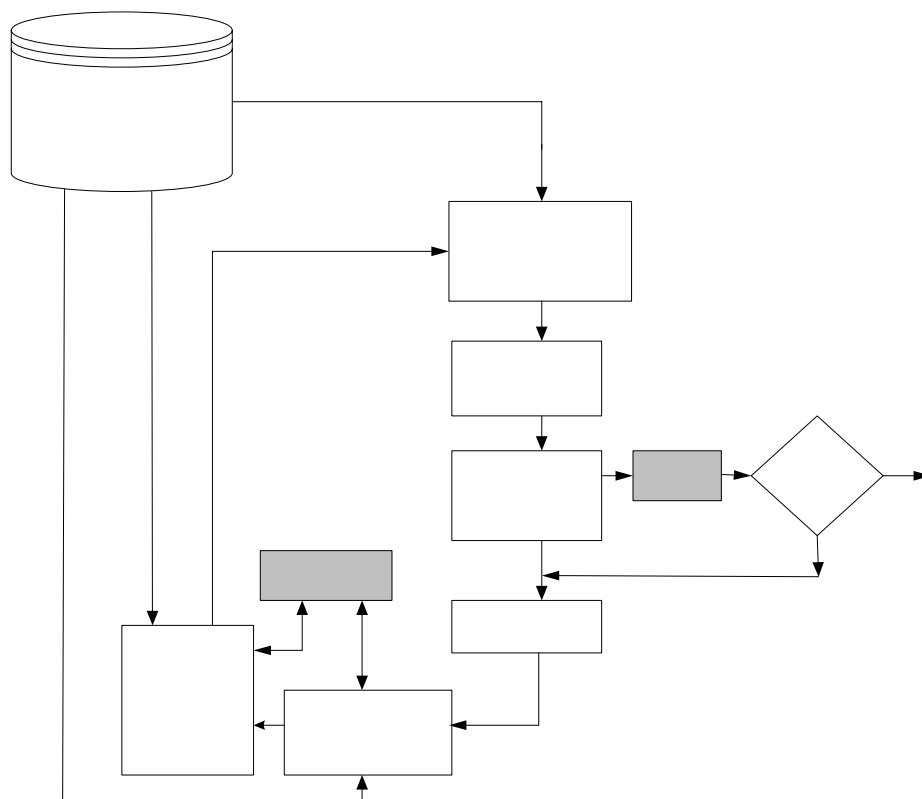

**Fig.1:** Flowchart of the Hybrid Algorithm specialized for the optimization of both structure and parameters of filters.



**Fig. 2:** Template circuit. The evolved circuit produced by evolution process. The source and load are not changed in the evolution process.

Fig. 3 shows a representation example. Fig. 3(a) presents an evolved circuit with eight building-blocks ( $b_1, b_2, b_3, \dots, b_8$ ). Fig. 3(b) shows the reduced matrix representation of the circuit. It carries the information about the building-blocks locations, but for simplicity purpose we use hereinafter the reduced matrix representation shown in Fig. 3(c).

This matrix does not allow the explicit representation of all information. The complete description (chromosome) is accomplished with pointers that indicate, for each non-zero entry, the positions in a database where the information about the associated building-blocks (structure and parameters) is stored. A chromosome is composed by three parts, such that the first part is coded in a reduced matrix representing the topology, the second part is coded in a list representing the building-blocks in each entry of the previous matrix. The third part consists of real numbers describing the corresponding electrical parameters of the circuit elements.

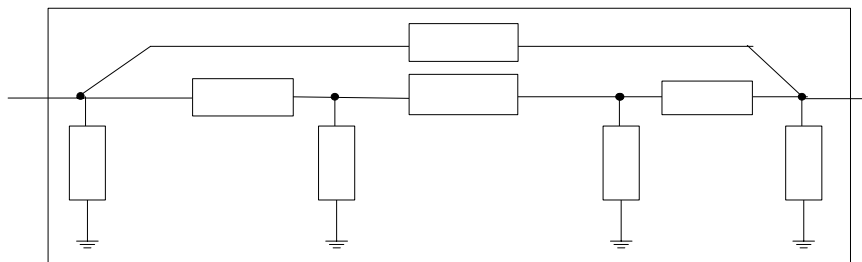

(a)

$$\begin{bmatrix} b_1 & b_5 & 0 & b_8 \\ 0 & b_2 & b_6 & 0 \\ 0 & 0 & b_3 & b_7 \\ 0 & 0 & 0 & b_4 \end{bmatrix}$$

(b)

$$\begin{bmatrix} 1 & 1 & 0 & 1 \\ 0 & 1 & 1 & 0 \\ 0 & 0 & 1 & 1 \\ 0 & 0 & 0 & 1 \end{bmatrix}$$

(c)

**Fig. 3:** Circuit representation (a) Evolved circuit (b)-(c) Location of building-blocks into the reduced matrix.

Source  
Building-bl  
Input  
Port  
 $Z_E$

### B. Evaluation functions.

Two objective-functions are defined to allow a trade-off relation: (1) an error measurement based on the circuit performance evaluated through a frequency-domain circuit simulator; and (2) the structural-size measurement based in the topology of circuit — the circuit size, given by the number of nodes, in this work. The circuit simulator computes the frequency responses (the scattering parameters) over a set of user-defined frequencies. After that, the algorithm calculates the absolute deviations average between the computed aggregate responses and the desired responses, an error measurement, see (1), which are predefined through a user-defined the scattering parameters masks ( $|S_{21}|$  and  $|S_{11}|$ ).

$$Error = \sum_{i=1}^2 \frac{1}{n_k} \sum_{j=1}^k \left( \sum_{R_{S_{i1}}(f_j)_{k \notin E_k}} |R_{S_{i1}}(f_j) - L_{S_{i1}}(f_j)| \right) \quad (1)$$

where  $k$  is the number of frequency ranges used in circuit evaluation, each one with its specification,  $L_{s_i}(f_j)$  is the rejection level limit,  $R_{s_i}(f_j)$  is the frequency response given by a circuit simulator,  $E_k$  is the set of frequency responses that complied with specifications, and  $n_k$  is the number of points, in the  $k^{th}$  frequency range.

### C. Evolutionary Strategies

*Structural inputs.* The algorithm uses topology-constrained approach as in other recent works [12][13] (combination of the building-blocks and the topology-constraints rules). These elements allow us the use of the expert-knowledge to reduce the search space, to avoid anomalous circuits, and to produce well-structured circuits. The building-blocks can be structures known in literature or can be defined by the user. The rules allow us to make constraints in topology, for example: to allow only inline topologies, to establish the maximum number of the connections between building-blocks (number of the connection between source-load or between other elements of the circuit), to establish insertion types of the building-blocks in circuit (serial, parallel, cascade, mixed), to establish the type of coupling between some building-blocks (direct, cross) etc. These restrictions are used to compose the initial population and to accept or not a circuit formed in the evolution process.

*Initialization.* The population is initialized randomly with circuits (individuals) that use the template circuit in Fig. 2, which are composed by building-blocks (genes) randomly selected from the database according to a reduced matrix previously filled, and considering topology-restrictions rules. Only one building-block is placed at each entry and each parameter of the block is set up with a value randomly chosen from user-defined range. It is possible use of rules defined by an expert user (for example, generate only inline topologies). Intelligent inputs greatly improve the quality of the initially generated circuits. In the case the expert inputs are not a hand, the algorithm runs a standard

procedure, namely, it generates an arbitrary sized matrix associated with a valid fully connect circuit. For this, all the entries are filled with high probability, and then a specific algorithm verifies if the generated matrix corresponds to a connected circuit, if not, a repairing procedure to fully connect the circuit is executed.

*Classification and selection.* In order to generate high-performance but small circuits, a biobjective selection approach – the crowded-comparison operator, extracted from the NSGA-II [19] – is applied in this method. The two evaluation functions (objective-functions) previously stated in this paper are taken into account. The elite individuals of the population, i.e. the first Pareto front, are found out by applying this classification method. The selection scheme used in this work is the well-known binary tournament method. This approach provides the balance between performance and size of the solutions, and, consequently, makes it possible to naturally reduce the tendency of the process for producing larger circuits as the population evolves. Additionally, it allows the extraction of building-blocks, derived from the evolution process, (building-blocks hypothesis [20]) which can be used in the next stage to produce the competitive circuits with some degrees of structural redundancy (building-blocks naturally generated by the classification/selection mechanism).

*Local search.* In this hybrid method, a local search process assists the Evolutionary Algorithm for fitness improvement of candidate circuits, refining their parameters in order to avoid good topologies with non-optimized parameters values to be prematurely discarded. The evaluation criterion to accept new parameters for given topology is mono-objective, based in the performance function. This process takes place in two points of the evolution cycle. After the classification process, the local search method is applied to each elite individual. Also, the local search procedure is carried out after the crossover and mutation procedures. Doing so, the topology space is explored and, subsequently, the parameters of the new topologies are improved. As a result, offspring solutions will be able to fairly compete with the current elite set for composing the elite of the next generation. We use the Simulated Annealing technique [21] with few iterations and predefined temperature values such that only a low computational effort is spent with each local search.

#### D. 2D Topology Crossover Operator

Only one crossover operator is proposed. Fig. 4. sketches this operator. Each crossover operation generates only one offspring. The crossover occurs as follows. Given two reduced matrices, a cut point in parent matrix 1 is randomly chosen, such that four regions are defined, as shown in Fig 4(a). After that, a square sub-matrix in parent matrix 2 is arbitrarily defined, as shown in Fig. 4(b). Fig. 4 (c)-(e) illustrates the offspring composition. The blocks  $R_1$ ,  $R_2$ ,  $R_3$  and  $R_4$  in the offspring matrix are from the parent matrix 1, the block  $R_5$  is from the parent matrix 2, and the block  $R_6$ , is randomly chosen from the corresponding block in parent matrix 1 or from 2, or an alternative between one and other, in each entry of the matrix - it represents a node set connected during the cascading operations. Three types offspring composition are possible and equiprobable: overlapping, as in Fig. 4(c);

truncating, as in Fig. 4(d); and splitting, as Fig 4(e). Then, the proposed crossover operator can explore the containing knowledge in the parents, and also can promote the diversity of structures. We applied some compositions of crossover operator, and the offspring circuits are presented in Fig. 5. Fig 5(e)-(f) illustrates a possible result obtained by overlapping, Fig 5(g)-(h) by truncating, and Fig. 5 (g)-(h) by splitting. These examples demonstrate the potential of proposed crossover operator, since parent's structural information are preserved.

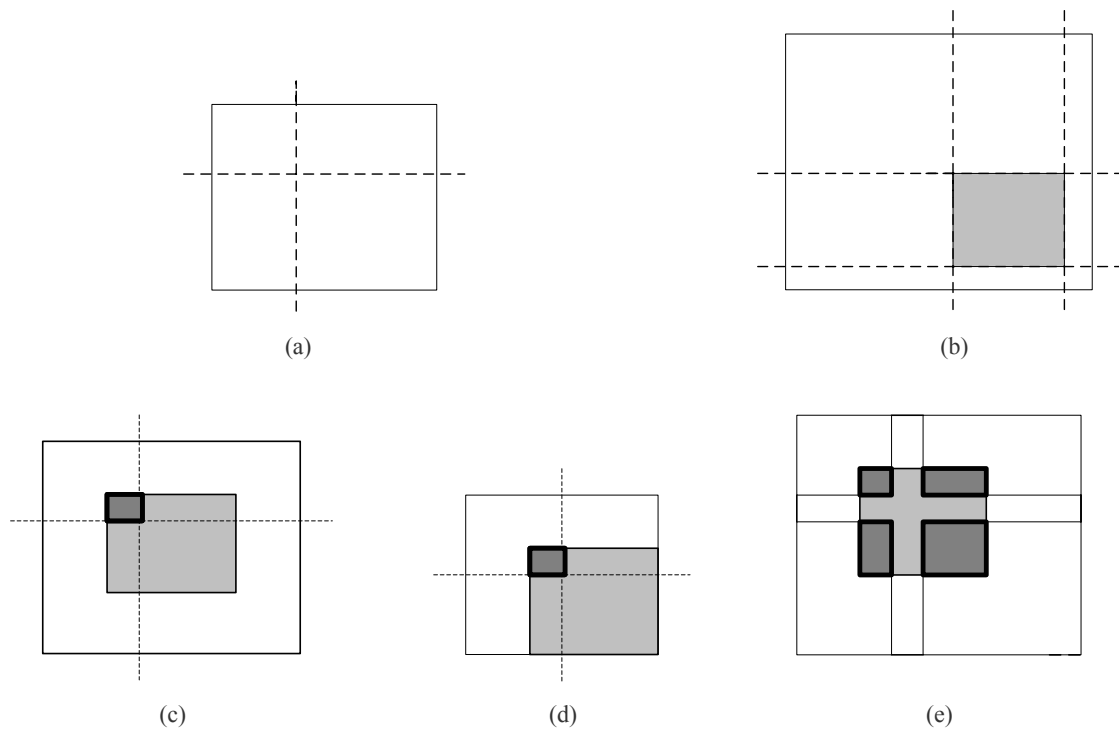

**Fig. 4:** Crossover operator (a) Parent matrix 1 (b) Parent matrix 2 (c) Overlapping (d) Truncating (e) Splitting.

#### E. 2D Topology Mutation Operator

Four types of topology mutation were defined. They are equiprobable. The circuit mutation is performed via one of the following operations: (1) adding a randomly chosen building-block, without position restriction; (2) deleting a building-block, since the circuit remains connected; (3) deleting a node, by removing a row/column associated to the node, given that the circuit remains connected; (4) inserting a node, by adding a row/column associated to the new node, and a building-block in order to keep the circuit connected.

#### F. Parameter Mutation Operator

All the parameters of the building-blocks of the circuit may possibly suffer mutation with lower probability. If a parameter is to be mutated, a new parameter value is randomly generated, observing a predefined range of possible values.

$R_1$

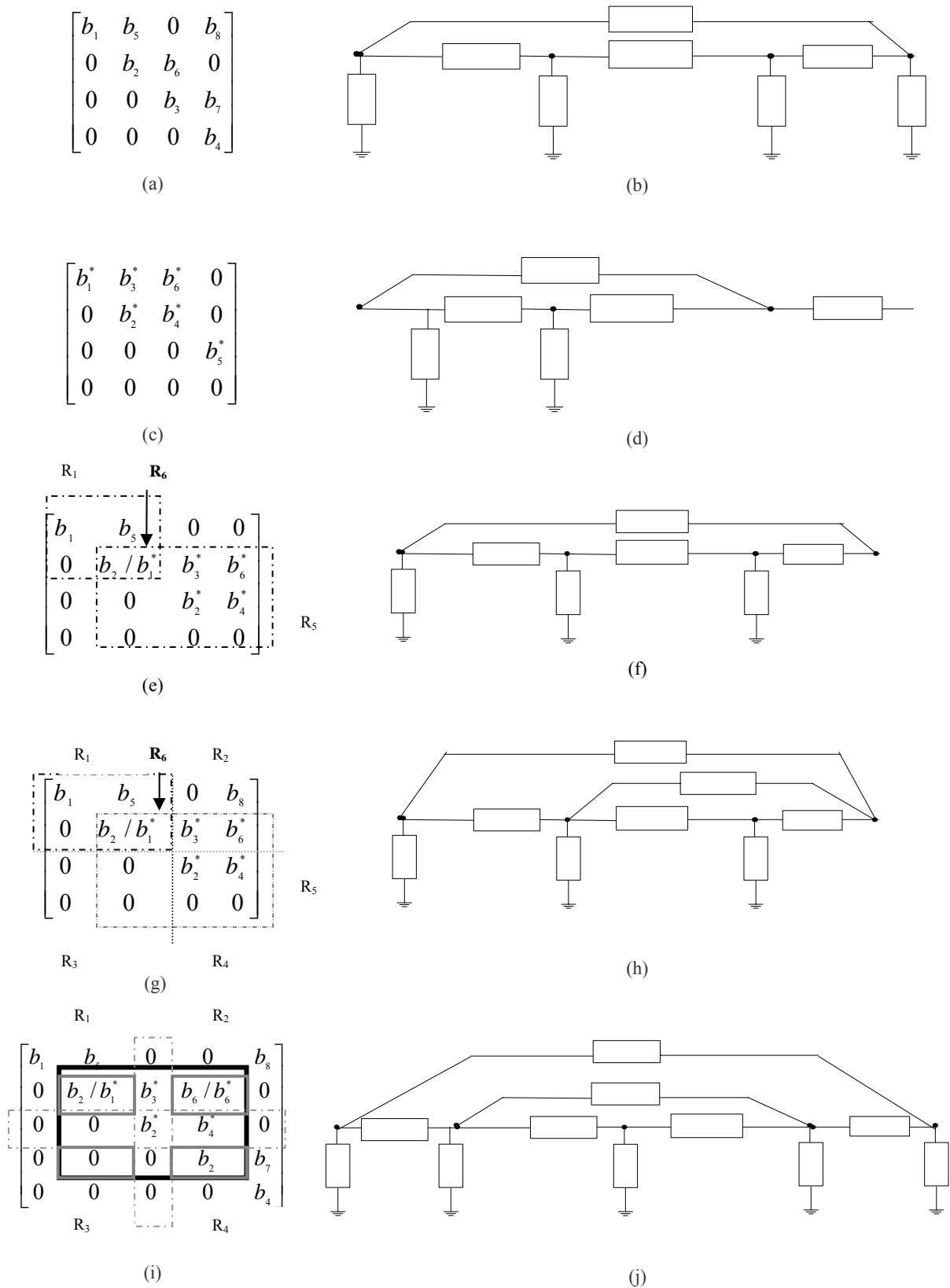

**Fig. 5:** Example of the crossover operator processing (a) Parent matrix 1 (b) Parent circuit 1 (c) Parent matrix 2 (d) Parent circuit 2. Overlapping type crossover operator- see Fig. 4(c) (e) Offspring matrix (f) Offspring circuit. Truncating type crossover operator - see Fig. 4(d) (g) Offspring matrix (h) Offspring circuit. Splitting type crossover operator - see Fig.4(e) (i) Offspring matrix (j) Offspring circuit



### III. EXPERIMENTS AND RESULTS

We have synthesized several different filters with several complexity levels using the proposed method. It successfully produced lumped-elements filters that complied with the desired specifications, and the time spent for the entire synthesis process was modest.

In this work, we chose to present four filter synthesis experiments. In all the experiments we used an initialization with 30 circuits having size at most of ten nodes, crossover probability of 100%, topology mutation probability of 20%, and parameters mutation probability of 5%. The high mutation probabilities are applied in the dominated offspring after multi-objective classification to promote diversity. The performance of a circuit was simulated at 100 frequencies points in the frequency range. The outcomes are compared with those obtained by the conventional and/or evolutionary approaches.

*Experiment 1:* In the first experiment we synthesized a microwave bandstop filter that presents the following specifications (in the normalized frequency range): the required  $|S_{21}|$  in the frequencies ranges  $[-10, -4]$  and  $[4, 10]$  is  $-0.5$  dB, and in the  $[-1, 1]$  is the  $-25$  dB; the required  $|S_{11}|$  in the frequencies ranges  $[-10, -4]$  e  $[4, 10]$  is  $-10$ dB, and in the  $[-1, 1]$  is the  $-0.5$  dB. In [16] the direct synthesis is discussed and some solutions are presented for the same specifications. We employ the two models shown in Fig. 6 (see the structures and the predefined ranges of the components values). The first model represents a block with an admittance inverter, capacitance, and reactance, as in Fig 6(a). The second model represents an admittance inverter, as in Fig. 6(b). The rules used are: to produce only inline topologies, inserting model 1 only in serial, and model 2 in serial or parallel, at any time in the circuit.

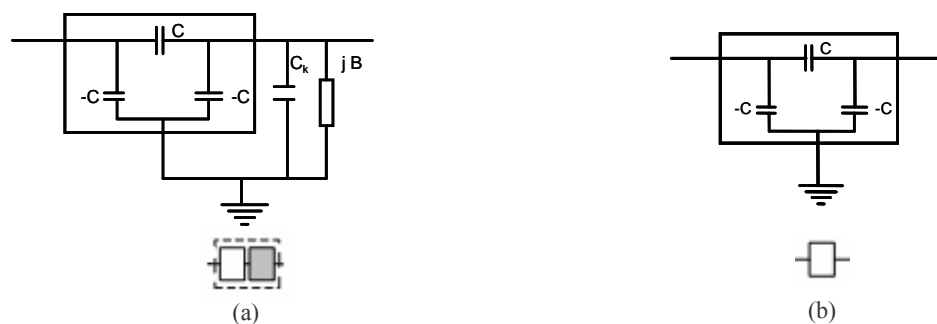

**Fig. 6:** Experiment 1– Insertion models in the evolution process a) model 1 b) model 2. The predefined normalized range of the components values: capacitance  $C \in [0, 10]$ , capacitance  $C_k \in [4, 8]$ , and reactance  $jB \in [5, 9]$ .

*Results.* We executed 10 runs of the proposed synthesis. The two best topologies are in Fig. 7. The solutions were obtained before the 50<sup>th</sup> generation (17,700 circuit evaluations). The outcomes are very regular, presenting redundant structures generated through the evolution process. Fig. 8 shows the frequency responses of both solutions, which comply with the specifications.

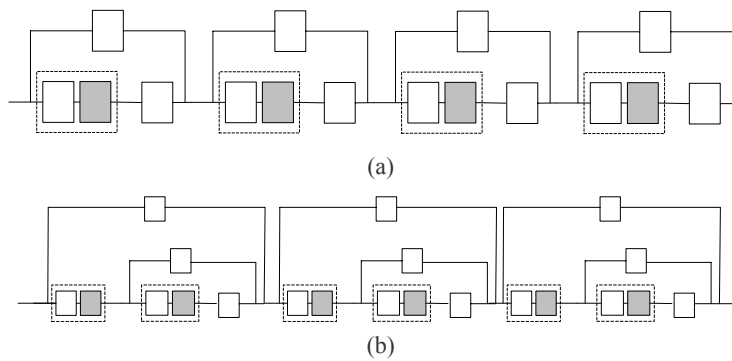

**Fig. 7:** Experiment 1—Topologies obtained by proposed method. (a) Solution 1 – final solution formed by CT sections. (b) Solution 2 – final solution formed by CQ sections.

We can notice that the outcomes topologies (in both solutions) present partial structures, from the evolution process, have coupling between the building-blocks, configuring a CT sections, in Fig. 7(a), and a CQ sections, in Fig. 7(b). This structures can be found in solutions by conventional design like those presented in [14][15]. The final solution is formed by these redundant structures, and the circuits are very regular (assembled as a cascade). The solutions are compatible with the rule to constraint structural that is to allow only inline topologies. In [16], the authors present a solution full-coupled, for the same specifications.

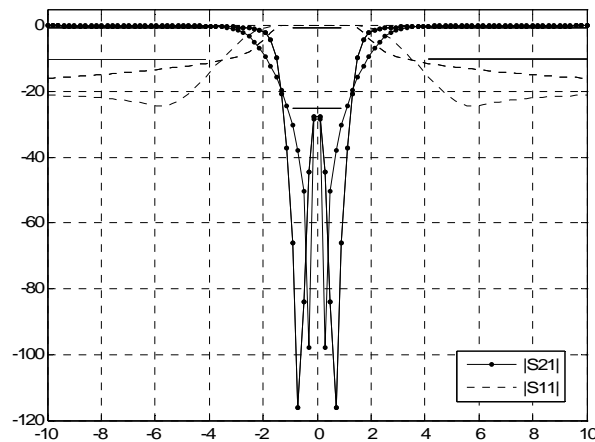

**Fig. 8:** Experiment 1—Frequency responses of the scattering parameters ( $|S_{21}|$  e  $|S_{11}|$ ) of both solutions.

*Experiment 2:* The second experiment is a bandpass filter in the 1800 MHz frequency range, described in [14]. The specifications are: passband edges (1703.4, 1787.3) MHz, upper stopband selectivity  $> 65$  dB for frequency  $> 1805$  MHz. We chose this filter due to its highly asymmetric bandpass response, which offers a considerable difficulty degree. We defined three building-blocks: an inductor, a capacitor, and a combination of the inductor and capacitor in parallel. The initial population was obtained the following standard procedure (see the initialization topic, in evolutionary strategies section).

Results. In all of the 10 runs we achieved results very close to the specifications. The Fig. 9 shows the best topology obtained having 9-nodes (about 50,000 circuit evaluations). Fig. 10 (a) presents the frequency responses that comply with the specifications. Fig. 9 (b)-(d) presents other topologies obtained with error very close to the specifications. We can notice that all the solutions present CT sections, good for providing asymmetric response [14]. Here, these sections were formed naturally by the evolution process. In [14], the authors, using conventional design, exposed a solution containing two CT sections and 7-nodes. Our present results show some similarities to the conventional design, but we obtained some solutions with lower size (5/6-nodes, for example).

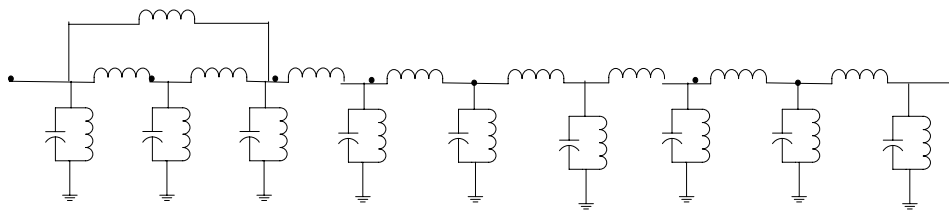

L(nH), C(pF), R( $\Omega$ ):  $L_1=0.26447, C_1=33.526, L_2=26.165, C_2=33.147, L_3=30.087, C_3=30.0072$   
 $L_4=0.26555, C_4=32.953, L_5=0.26991, C_5=32.457, L_6=0.26555, C_6=32.953$   
 $L_7=0.26991, C_7=32.457, L_8=0.26297, C_8=33.558, L_9=0.26259, C_9=33.046$   
 $L_{12}=6.6957, L_{23}=10.02, L_{13}=14.485, L_{34}=9.5314, L_{45}=10.652$   
 $L_{56}=9.5314, L_{67}=10.652, L_{78}=10.298, L_{89}=6.3797, R_s=R_L=50$

(a)

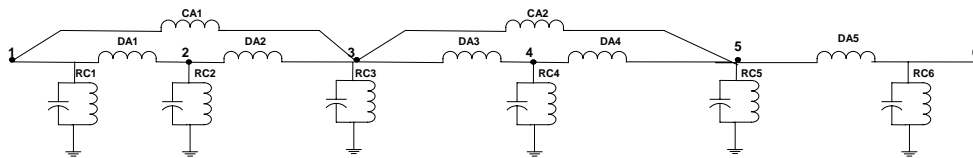

(b)

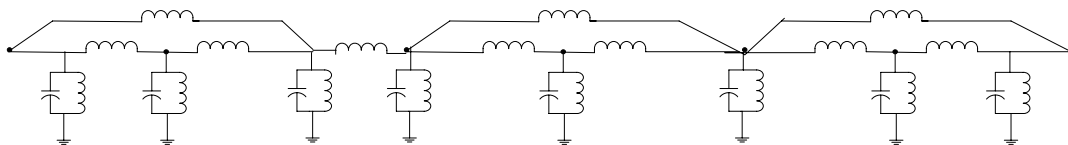

(c)

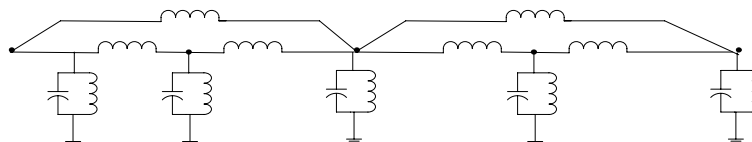

(d)

**Fig. 9:** Experiment 2 (a) Best topology and parameters values (b) – (d) Other topologies obtained for the experiment 2. Legend: DA (Direct—coupling) , CA (Cross—Coupling) , RC (Resonator Circuit).

$L_{13}$

$L_{12}$

$L_{23}$

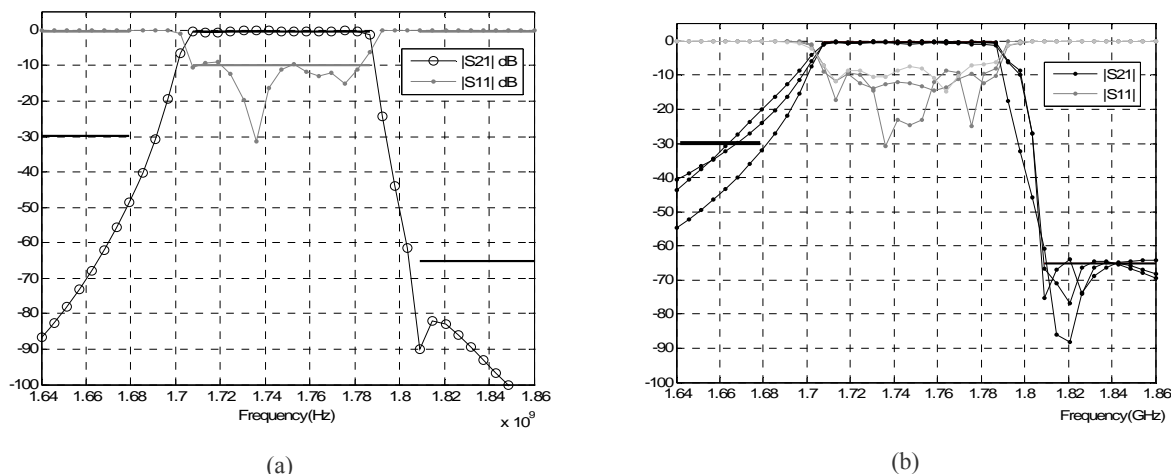

**Fig. 10:** Experiment 2 (a) Frequency response of best topology in Fig. 5 (b) Frequency response of other topologies obtained for the experiment 2. Legend: The thick black ( $|S_{21}|$ ) and gray ( $|S_{11}|$ ) lines represents the user-defined mask.

We aim to compare these results with results by other evolutionary methods. Then, we also synthesized the Nielsen Filter, a classical problem reported in literature, which is as highly asymmetric as the filter of experiment 2. Specifically for Nielsen filter in [9], using Genetic Programming was used 127,360,000 circuit evaluations, and the final circuit had 38 components; in [10], using Hybrid Genetic Algorithm, the author did not mention the spent computational effort, and the final circuit had 4-nodes, and using our method are used 16,000 circuit evaluations, and the best solution is a 4-nodes circuit. It demonstrates that our method is competitive. We mentioned this experiment because it is very similar to proposed filter synthesis in experiment 2, and can be used to evaluation the potential of presented evolutionary method.

*Experiment 3:* The third experiment is other bandpass filter. In this case, we used the same specifications achieved to microwave circuit in Fig. 11(a) – for the parameter  $|S_{21}|$  are  $-20$  dB in stopband  $[0.5; 2]$  GHz,  $-25$  dB in stop band  $[2.8; 4]$  GHz and  $-0.5$  dB in bandpass range of  $[2.375; 2.625]$  GHz. The specifications for the parameter  $|S_{11}|$  are  $-20$  dB in stopband  $[0.5; 2]$  GHz,  $-0.5$  dB in stop band  $[2.8; 4]$  GHz and  $-15$  dB in bandpass  $[2.375; 2.625]$  GHz. We available to evolution process two basic building-blocks: an inductor and a capacitor. We defined the following topology-constraints rules: to generate, preferably, inline topologies, to insert the two building-blocks in serial or parallel, and to allow direct or cross coupling.

*Results.* The best topology obtained has 3-nodes, achieved after 76 generations (about 30,000 circuit evaluations). It is very compact topology, containing only one inductive cross coupling. It can be noticed in Fig 11(b) that the proposed method naturally identifies and makes use of genetic building-blocks – for example, the parallel capacitor/inductor sub-circuits – created along the evolution process, as desired when consider the building block hypothesis [21]. In all of the 10 runs

we achieved results that accomplish the specifications. Fig. 11 and Fig. 12 present the best result obtained by our method. We can notice also some similarities between the topologies in Fig 11(a) and Fig. 11 (b). The synthesized filter (see Fig. 11(b)) presents the same resonator and coupling numbers that the measured physical filter (Fig. 5(a)). It is a preliminary result, but in future can be used in new works to extract circuit element values of the equivalent circuit model for the given filter.

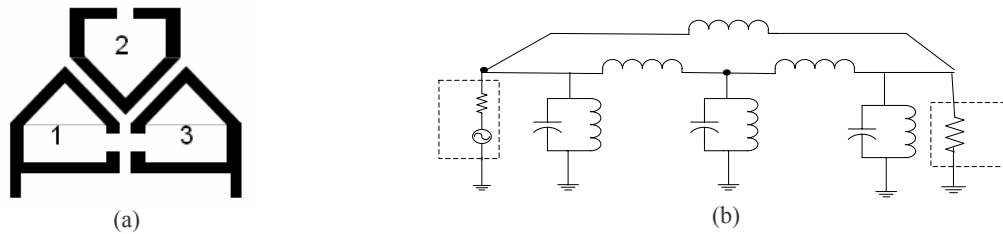

$$L(\text{nH}), C(\text{pF}), R(\Omega): \begin{array}{l} 1 \rightarrow 0: L = 0.5681, C = 8.6277, 2 \rightarrow 0: L = 0.5197, C = 9.4234 \\ 3 \rightarrow 0: L = 0.7759, C = 6.720, 1 \rightarrow 2: L = 3.546327 \\ 2 \rightarrow 3: L = 3.45162, 1 \rightarrow 3: L = 7.9892 \text{ nH} \quad R_s = R_l = 50 \end{array}$$

**Fig. 11:** Experiment 3 (a) Microwave structure (b) Best topology and components values synthesized by our method.

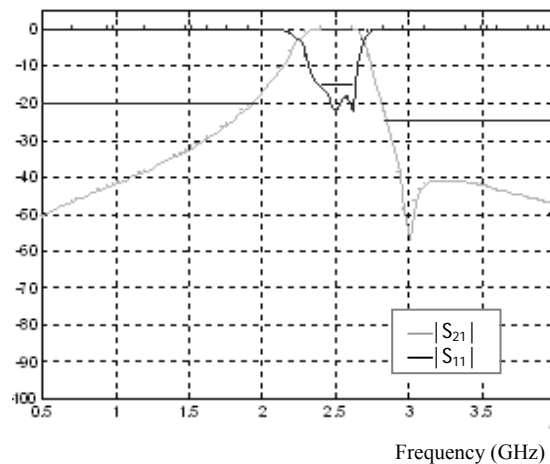
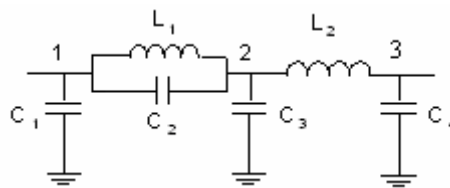

**Fig. 12:** Experiment 3–Frequency response of the best topology. Legend: The thick black ( $|S_{11}|$ ) and gray ( $|S_{21}|$ ) lines represents the user-defined mask.

*Experiment 4:* The fourth experiment was first proposed in [10] – a normalized equally-terminated low-pass filter. In other work [22], the authors used the same specifications except the frequencies were shifted to GHz range. The specifications are shown as follows: pass-band edge is 1.0 GHz, stop-band edge is 1.5 GHz, the maximum pass-band gain is  $-6\text{dB}$ , minimum pass-band gain is  $-7\text{dB}$ , maximum stop-band gain is  $-52\text{dB}$ . We synthesized the same filter. In our approach were used two building-blocks: an inductor and a capacitor, and they can be inserted in circuit in serial or parallel.

*Results.* Comparing the results, in [10] the author proposed a hybrid algorithm, and obtained a solution with six elements, using 80 circuits in population, after 100 generations (8,000 circuit

evaluations). In [22] the same problem was discussed and the authors solving it by a method using Genetic Programming, and topology-restricted approach with 200 circuits in population after 50 generations (10,000 circuit evaluations). However, the best solution by our method was obtained with only 792 circuit evaluations. Fig. 13 shows the best topology obtained, and respective components values. Fig. 14 presents the frequency responses that complied with the specifications. Then, our method is better than the others used in this comparison, presenting the same circuit size, but using lower circuit evaluations, which is the most time-consuming. On the other hand, a fully-compliant circuit obtained has only six elements, which is more economical than elliptic filters that are known as the most economical filters by traditional design approaches



$$C \text{ (pF)}, L \text{ (nH)}: C_1 = 3.75, C_2 = 1.21, C_3 = 9.24, C_4 = 7.91, L_1 = 6.5, L_2 = 7.75$$

**Fig. 13:** Experiment 4 –Best topology and components values of the low-pass filter synthesized by our method.

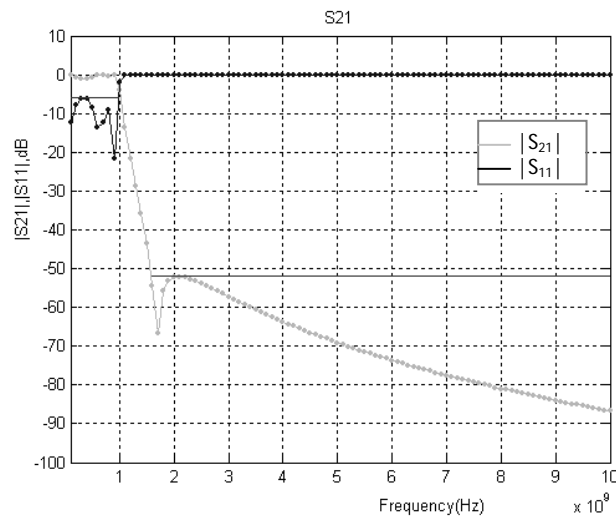

**Fig. 14:** Experiment 4 –Frequency response of the best topology. Legend: The thick black ( $|S_{11}|$ ) and gray ( $|S_{21}|$ ) lines represents the user-defined mask.

### III. CONCLUSIONS

High performance microwave filters are among the most critical components in the present and next generation wireless systems and their design optimization is a challenging task for successful design and operation of the entire system. In this work, we proposed a Hybrid Evolutionary Algorithm applied to design of microwave filters topologies. The proposed method has the advantage of reducing troublesome trials to specify the design parameters in the conventional

design procedure. It is capable of generating circuits that meet the design specifications. The expert knowledge-based approach allows the representation of a rich variety of circuit topologies, and also allows driving the evolution process toward well-structured circuits. The system requires a little expert knowledge from user to define the building-blocks and topology-constraints rules, and has been successfully used to produce different filters with several complexity levels. The number of required circuit evaluations is modest, as showed in the four examples presented. The convergence process is very fast if compared to the evolutionary synthesis methods, even those that use the topology-restricted approach, reported in the literature. In future works, we aim to make the synthesis introducing more objective functions, extending the representation for multi-port linear/nonlinear building-blocks. We intend also to make use of building-blocks composed by distributed elements like microstrip, transmission lines. These extensions will allow an exhaustive study for the extraction of new microwaves topologies. We also can employ this method for extraction of equivalent circuits of microwave components and discontinuities that is other interesting application.

## REFERENCES

- [1] Uhm, M., Lee, J., Yom, I., and Kim, J., "General Coupling Matrix Synthesis method for Microwave Resonator Filters of Arbitrary Topology", ETRI Journal, Vol. 28, no. 2, April 2006, pp. 223-226.
- [2] Cameron, R.J., Faugere, J.C., and Seyfert, F., "Coupling Matrix Synthesis for a New Class of Microwave Filter", IEEE MTT-S 2005, International Microwave Symposium, Long Beach, CA, June 2005.
- [3] Lenoir, P., Bila, S., Seyfert, F., Baillarget, D., and Verdeyme, S. "Synthesis and Design of Asymmetrical Dual-band Bandpass Filters Based on Network Simplification", IEE Transactions on Microwave Theory and Techniques, Vol. 54, no. 7, July 2006, pp. 3090-3097.
- [4] Jun, D.S., Lee, H.Y., Kim, D.-Y., Lee, S.S, and Nam, E.S., "A Narrow Bandwidth Microstrip Band-Pass Filter with Symmetrical Frequency Characteristics", ETRI Journal, Vol. 27, no. 5, October 2005, pp. 643-646.
- [5] Wang, H., Zhang, A.-J., and Fang, D.-G., "The Design of Cross-Coupled Microstrip Filter Exploiting Aggressive Space Mapping Technique", Microwave Conference - APMC2005 Proceedings, Vol. 5, 2005.
- [6] Chen, C.-Y, Hsu, C.-Y, "Design of a UWB Low Insertion Loss Bandpass Filter with Spurious Response Suppression", Microwave Journal, February 2006, pp. 112-116.
- [7] Weber, R.J. Introduction to Microwave Circuits: Radio Frequency and Design Applications. IEEE Press Series on RF and Microwave Technology. Roger, D. Pollard and Richard Booton, Series Editors, 2001.
- [8] Hu, J., Goodman, E. D, and Rosenberg, R.: "Robust and Efficient Genetic Algorithms with Hierarchical Niching and a Sustainable Evolutionary Computation Model". Proc. of the Genetic and Evolutionary Computation Conference, Lecture Notes in Computer Science, Springer, GECCO-2004, Seattle, Part I, pp. 1220-1232.
- [9] Koza, J. R., Bennett III, Andre, F.H. and Keane, M.A. "Automated Design for Both Topology and Components Values of Electrical Circuits using Genetic Programming". Genetic Programming 1996: Proceedings of the First Annual Conference. July 1996, Stanford University, Cambridge MA.1996, pp. 123-131.
- [10] Grimbleby, J. B. "Automatic Analogue Circuit Synthesis using Genetic Algorithms", IEEE Proceedings: Circuits, devices and systems, Vol. 147, no. 6, 2000, pp. 319-323.
- [11] Zebulum, R. S., Pacheco, M. A., and Vellasco, M., "Comparison of Different Evolutionary Methodologies Applied to Electronic Filter Design" – Proceedings of the IEEE International World Congress on Computational Intelligence, ICEC'98, Alaska, May, 1998, pp. 434-439.
- [12] Lai, Ming-Iu, Jeng, and Shyh-Kang, "Compact Microstrip Dual-Band Bandpass Filters, Design Using Genetic-Algorithm Techniques", IEEE Transactions on Microwave Theory and techniques, Vol. 54, No. 1, January 2006, pp.160-168.
- [13] Dastidar, T. R., Chakrabarti, P.P., and Ray, P. "A Synthesis System for Analog Circuit Based on Evolutionary Search and Topological Reuse". IEEE Transactions on Evolutionary Computation, Vol. 09, no. 2, April 2005, pp. 211-224.
- [14] Yildirim, N., Sen, O. A., Sen, Y., Karaaslan, M., and Pelz, D. "A Revision of Cascade Synthesis Theory Covering Cross-Coupled Filters", IEEE Transactions on Microwave Theory and Techniques, Vol. 50, no. 06, June 2002, pp.1536-1543.
- [15] Rosemberg, U., Amari, S. "Novel Coupling Schemes for Microwave Resonator Filters". IEEE Transactions on Microwave Theory and Techniques, Vol. 50, no. 12, 2002, pp. 2896-2902.
- [16] Amari, S., and Rosenberg, U. "Direct Synthesis of a New Class of Bandstop Filters". IEEE Transactions on Microwave Theory and Techniques, Vol. 52, no. 02, February 2004, pp. 607-616.

- [17]Mesquita, A., Salazarand F. A., and Canazio, P. P. "Chromosome Representation through Adjacency Matrix in Evolutionary Circuit Synthesis". NASA/ Conference on Evolvable Hardware. 2002, pp. 102-112.
- [18]Im, C.-H., Jung, H.-K. and Kim, Y.-J. "Hybrid genetic algorithm for electromagnetic Topology Optimization", IEEE Transactions on Magnetics, Vol. 39, no. 5, September 2003. pp. 2163-2169.
- [19]Deb, K., Pratap, A., Agarwl, S., and Meyarivan, T. "A Fast and Elitist Multiobjective Genetic Algorithm: NSGA-II". IEEE Transactions on Evolutionary Computation, Vol. 6, no. 2, April 2002, pp. 182-197.
- [20]Goldberg. Genetic Algorithms in Search, Optimization, and Machine Learning, 1989.
- [21]Michalewicz, Z., Fogel, D.B.: How to Solve It: Modern Heuristics. 2nd ed. Revised and Extended, Spring Verlag, 2004.
- [22]Hou, Hao-Sheng, Chang, Shoou-Jinn, and Su, Yan-Kuin, "Practical Passive Filter Synthesis using Genetic Programming", IEICE Trans. Electron, vol. E88, No. 6, june 2005, pp. 1180-1185.